

KNITTING MACHINE TABLE

COMFORT

СТОЛ ДЛЯ ВЯЗАЛЬНОЙ МАШИНЫ

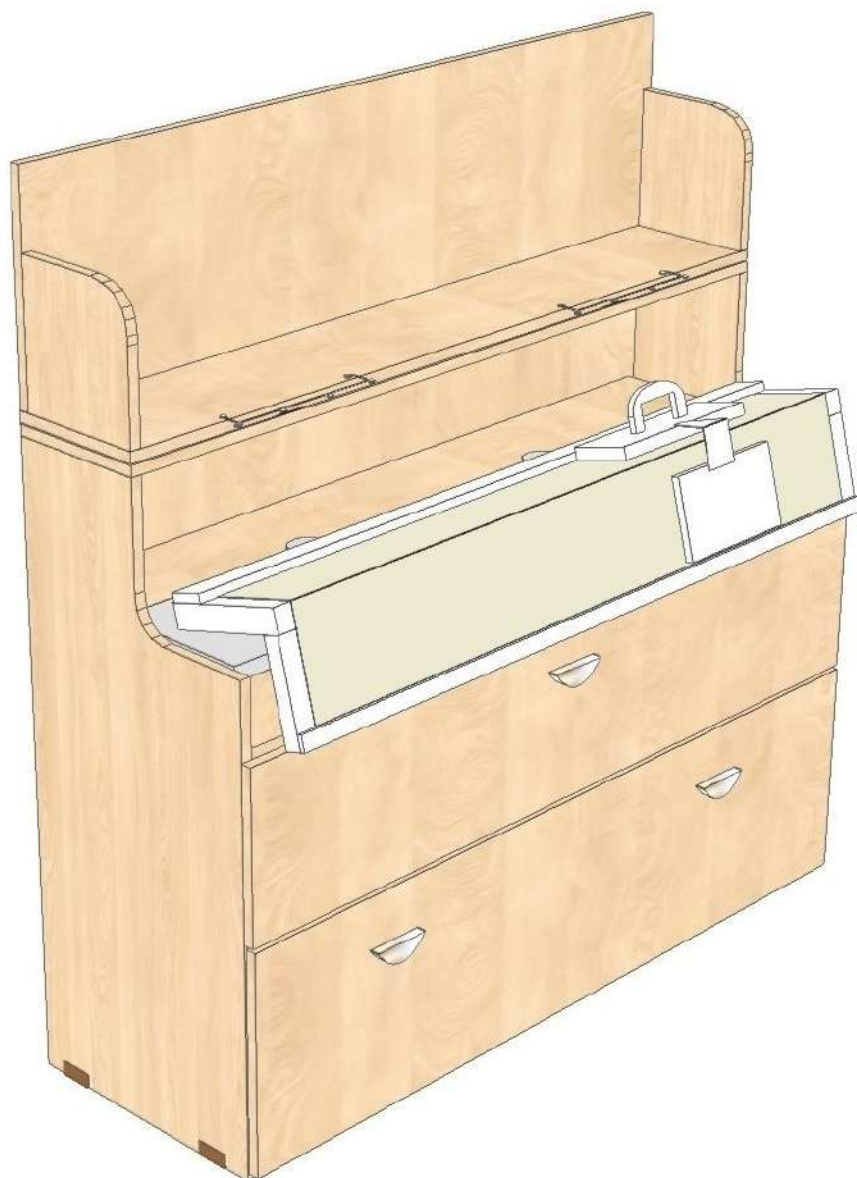

SYMBOLS



ATTENTION

ВНИМАНИЕ



ASSEMBLY & ADJUSTMENT

СБОРКА РЕГУЛИРОВКА



OPERATION

ЭКСПЛУАТАЦИЯ



STORAGE

ХРАНЕНИЕ

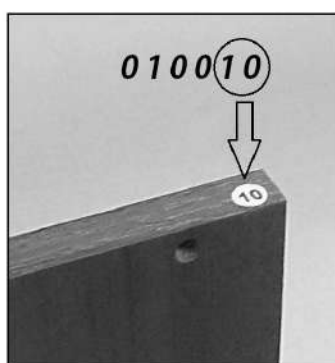

INDICATING MARK

ОБОЗНАЧЕНИЕ



SPECIAL OPERATION

СПЕЦИАЛЬНЫЕ ОПЕРАЦИИ

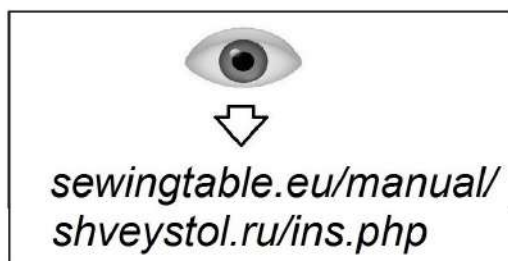

WATCH

СМОТРЕТЬ

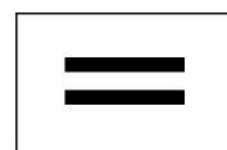

EQUALITY

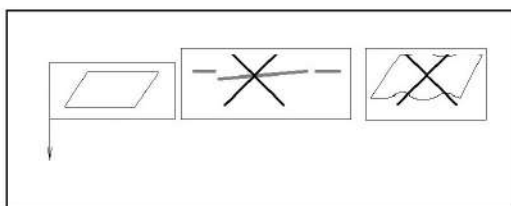

РАВЕНСТВО





EVEN SURFACE



РОВНАЯ ПОВЕРХНОСТЬ



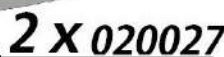











010001 1x	010002 1x	010003 1x	010004 1x
010005 1x	010006 1x	010007 1x	010008 1x
010010 1x	010011 1x	010017 1x	010018 1x
010024 1x	010025 1x	010026 1x	010027 1x
010029 1x	010033 1x	010035 1x	010036 1x

<p>2x 020007</p> 	<p>6x 020023</p> 	<p>4x 020024</p> 
--	--	--

<p>2x 020025</p> 	<p>2x 020026</p> 	<p>2x 020027</p> 
--	---	---

<p>020028</p>  <p>2x</p>	<p>2x 020029</p> 	<p>5x 020031</p> 
--	--	---

<p>2x 020032</p> 	<p>2x 020030</p> 
--	--

<p>030001</p>  <p>3 * 16</p> <p>4x</p>	<p>030002</p>  <p>3,5 * 16</p> <p>30x</p>	<p>030003</p>  <p>6,2 * 50</p> <p>32x</p>	<p>030033</p>  <p>4,2 * 13</p> <p>20x</p>	<p>030006</p>  <p>2,9 * 13</p> <p>4x</p>	<p>030008</p>  <p>φ4</p> <p>12x</p>	<p>030009</p>  <p>M4 * 20</p> <p>12x</p>
<p>030011</p>  <p>φ15</p> <p>32x</p>	<p>030012</p>  <p>φ18</p> <p>21x</p>	<p>030013</p>  <p>L = 35</p> <p>21x</p>	<p>030014</p>  <p>φ15 h12</p> <p>21x</p>	<p>030015</p>  <p>φ8 * 30</p> <p>12x</p>	<p>030025</p>  <p>M5 * 30</p> <p>8x</p>	<p>030026</p>  <p>8x</p>

<p>2x 040004</p> 
--

<p>2x 050001</p> 



S 4 *

S 10

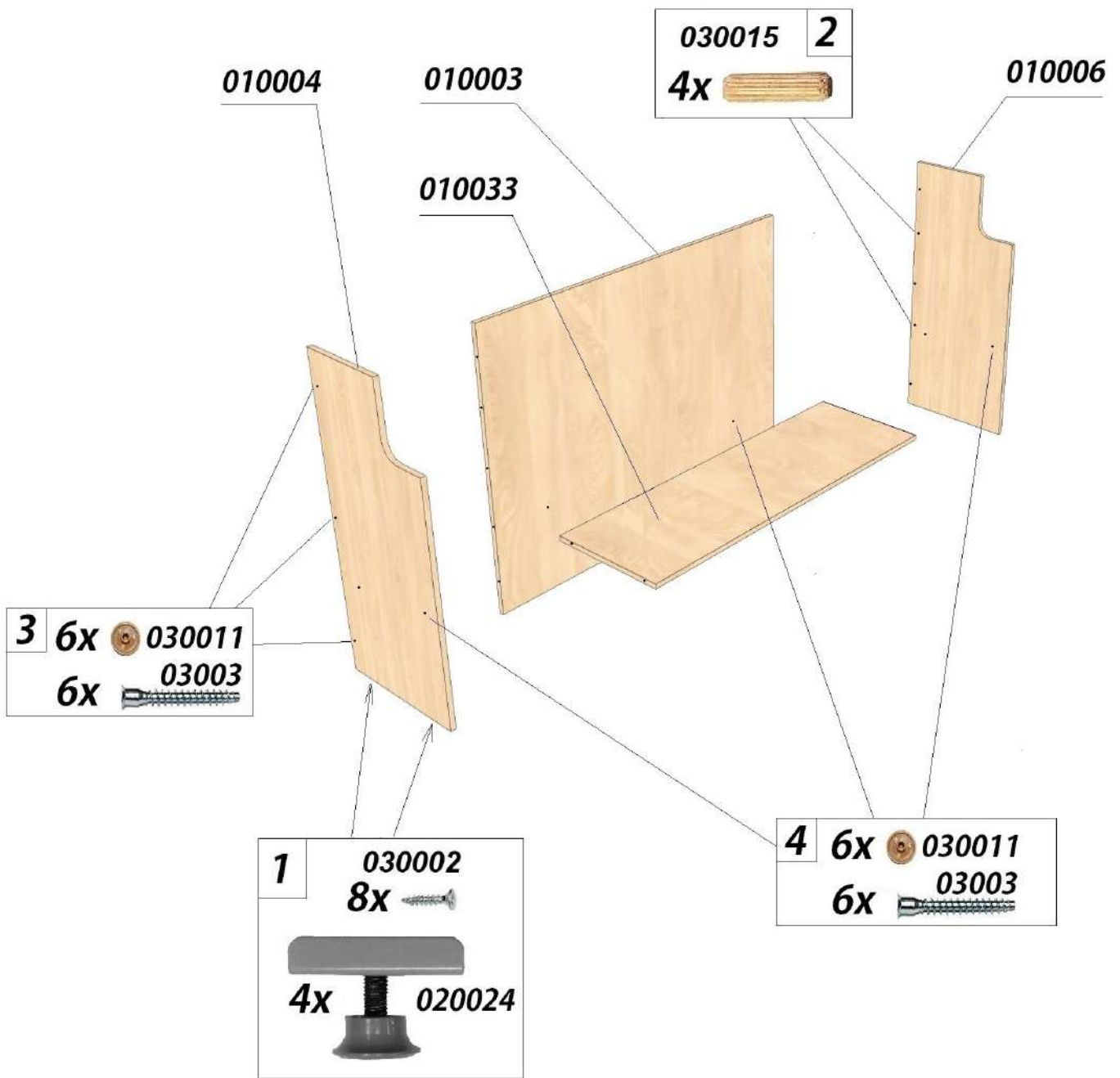

* Входит в комплект стола.
Included into table set.

5 2x 040004
2x 020025

010005
010017

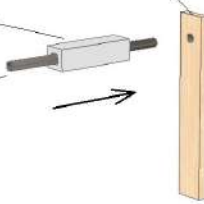

6 6x 030011
6x 03003

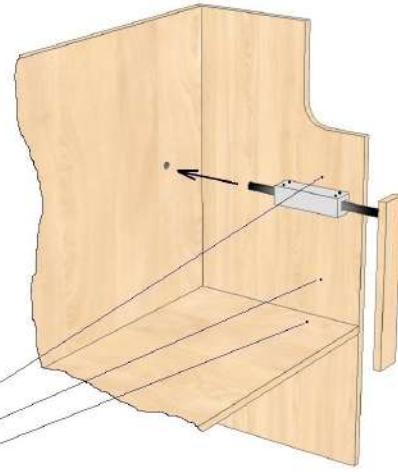

7
3x 030011
3x 03003

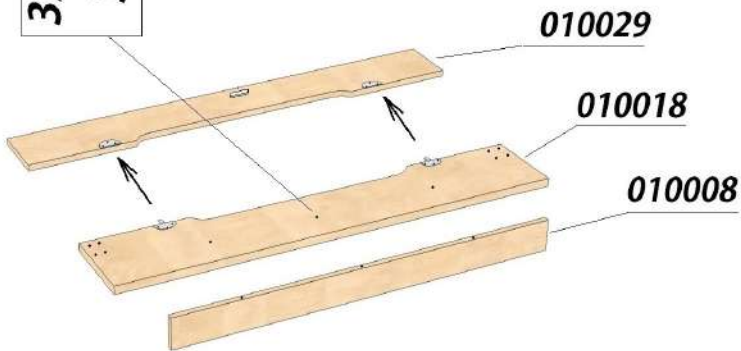

8 8x 030025
8 8x 030026
9

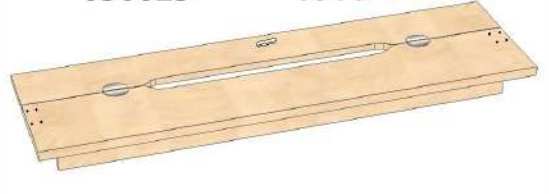

10 030002
4x
020028
2x

11 4x 030006
2x 020026

15 030002
10x
2x 020007

14 2x 020030
8x 030002

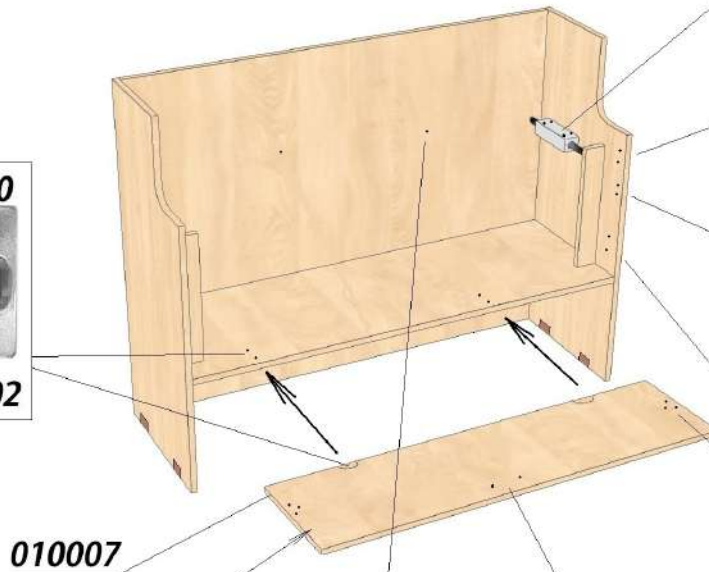

16 020027
2x
030001
4x

12 2x 020029

13 030008 030009
2x 2x
1x 020031

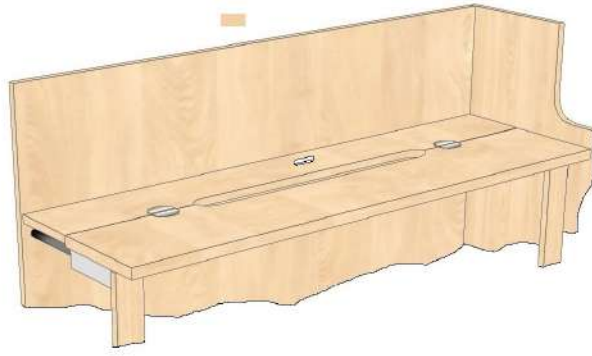

16

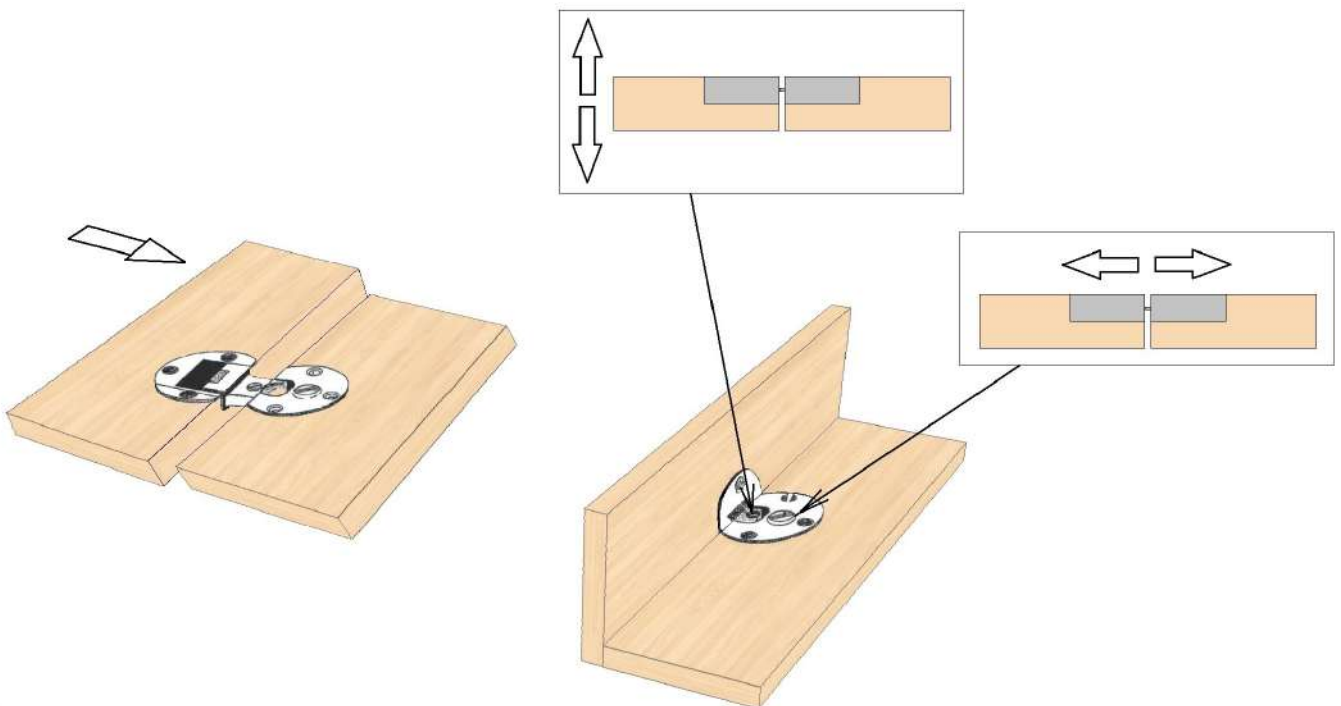
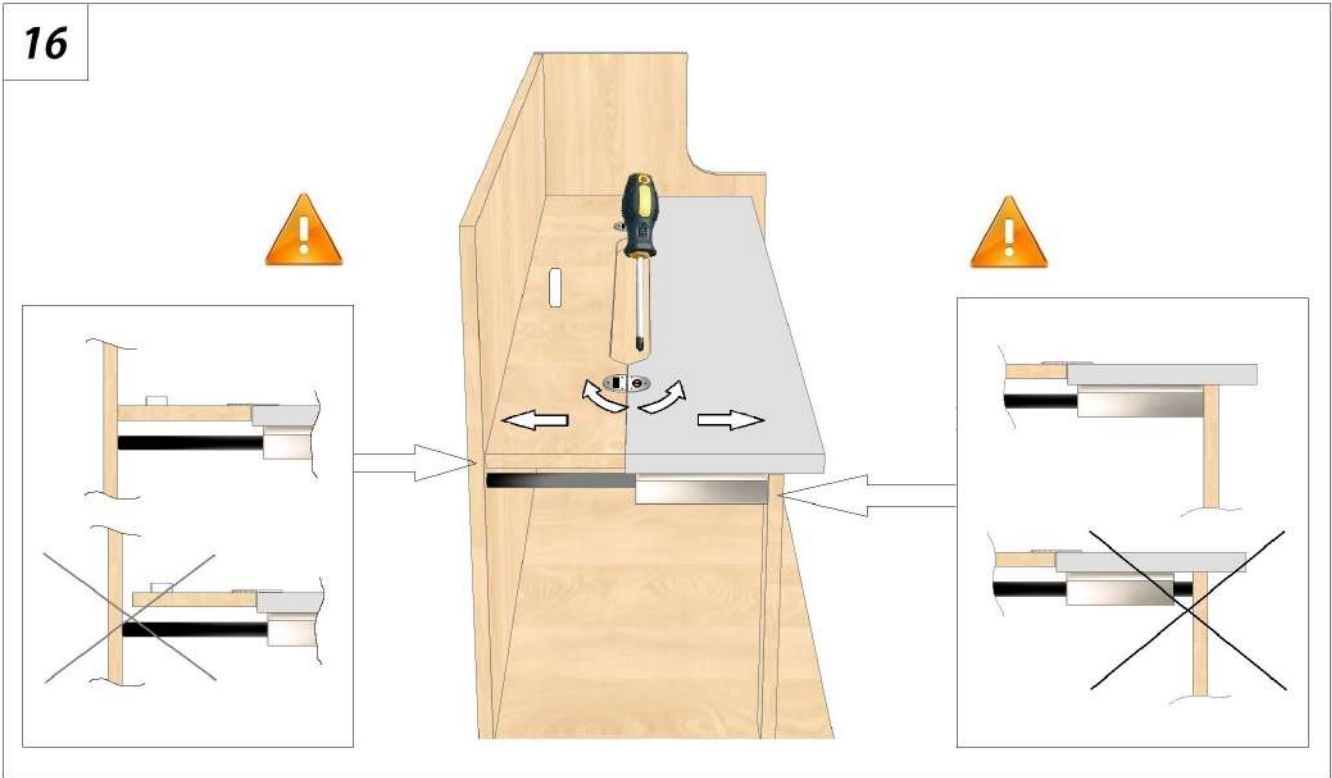

6

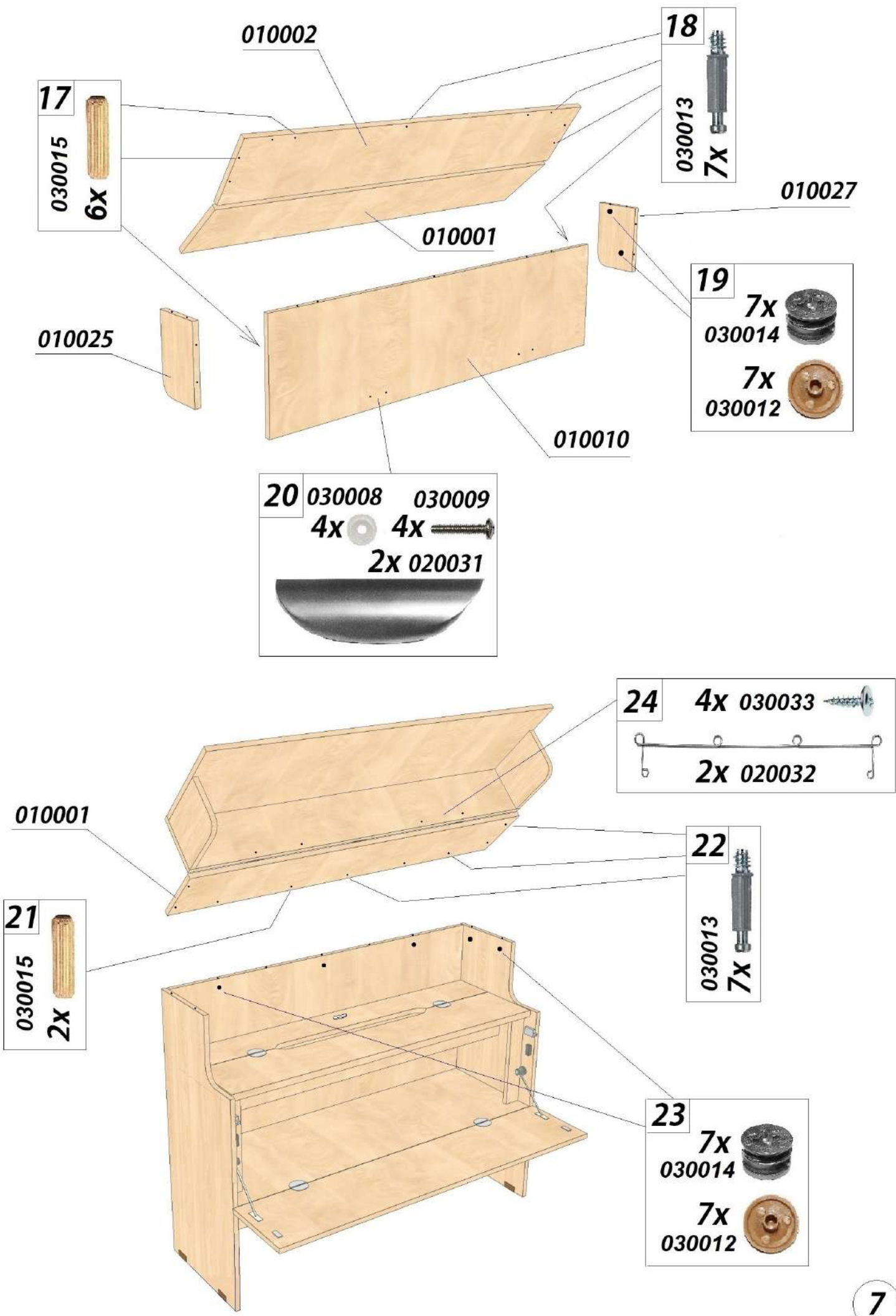



010024

010036



010035

010026

010011

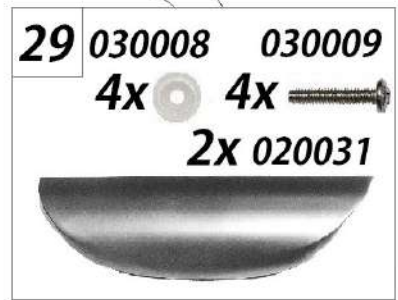

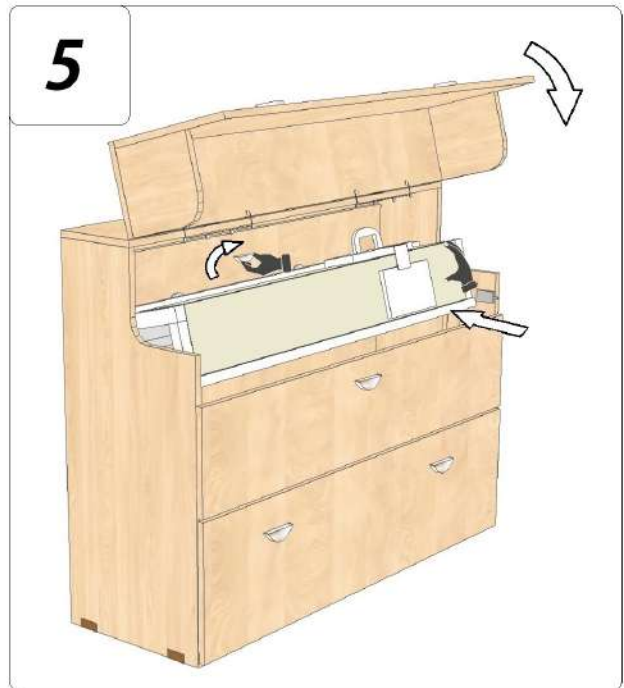
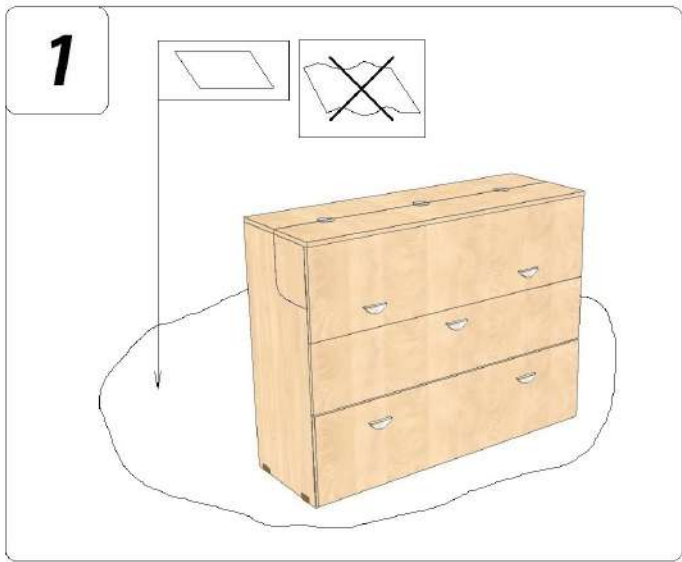
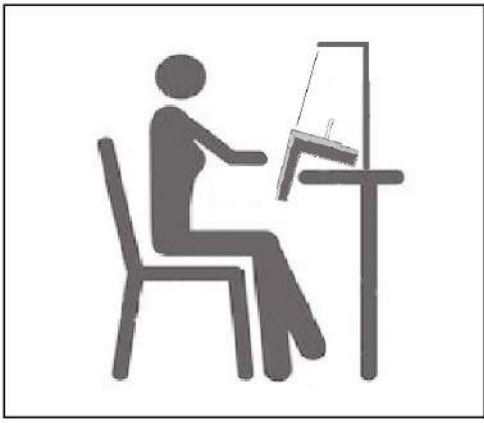

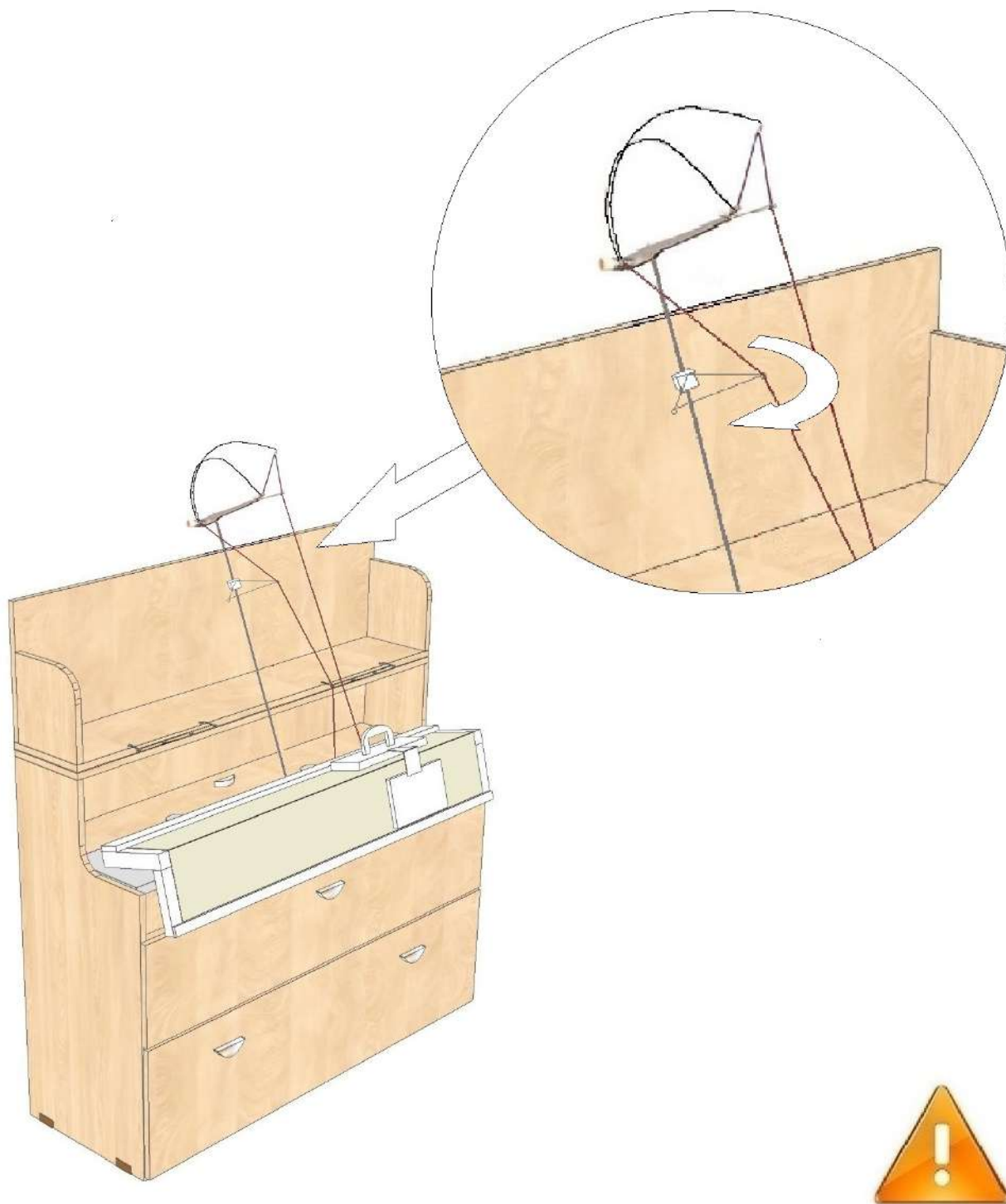

To ensure normal thread unwinding we recommend the use one of eight thread guide in table surface and thread guide on metal support (please turn it to find right position.

Для обеспечения правильного схода нити с конуса рекомендуем использовать любой из восьми наиболее подходящий нитенаправитель стола и нитенаправитель на стойке вязальной машины , предварительно повернув его в свою сторону.

Accessories. Paraffin holder

Аксессуары. Парафинодержатель

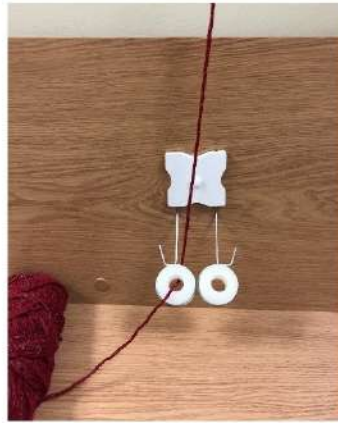

<p>1x</p>	<p>1x</p>	<p>1x</p>	<p>2x φ 38</p>
	<p>1x</p>	<p>1x 3,5*19</p>	

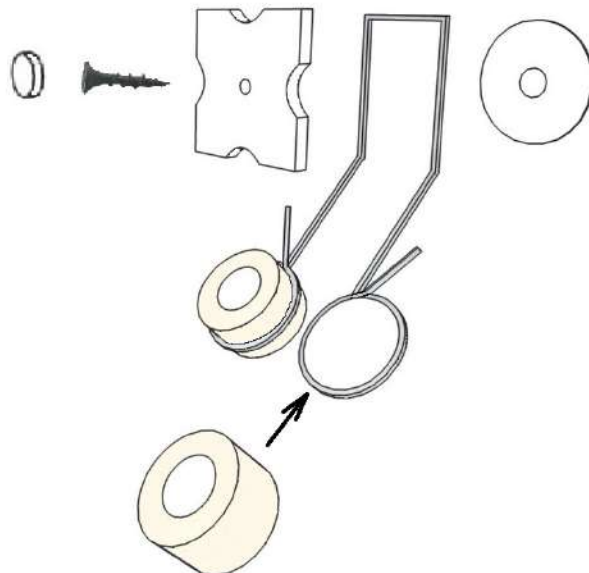

Accessories. Laptop shelf

Аксессуары. Полка для ноутбука

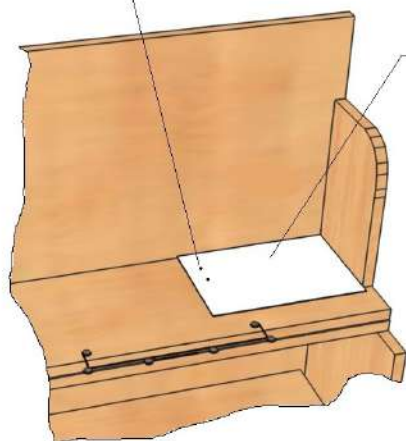
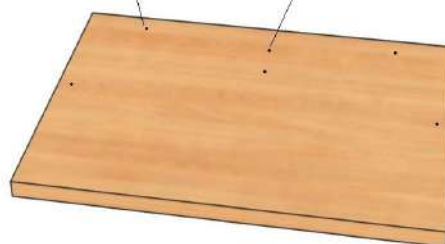

Stencil
Шаблон

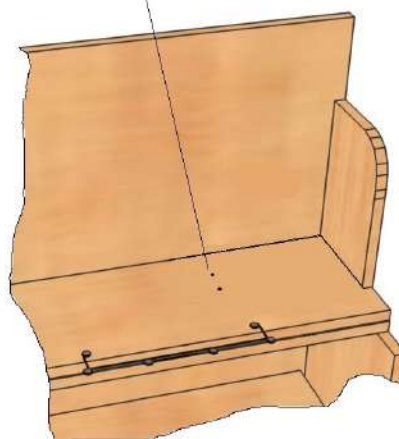

5

